

NK-L314- 5005U/5300U/5500U

95*82 Broad Well Comlac Board

特点 Feature

- Intel® 5th Gen. U Dual Core Processors i3-5005U ,base Frequency 2.0GHz up to 2.9GHz),TDP 15W
- Intel® 5th Gen. U Dual Core Processors i5-5300U ,base Frequency 2.3GHz up to 2.9GHz),TDP 15W
- Intel® 5th Gen. U Quad Core Processors i7-5500U ,base Frequency 2.4GHz up to. 3.0GHz),TDP 15W
- Support 1 x DDR3L-1333/1600MHz SO-DIMM slot, up to 8GB
- Support 1 x eDP,2 x DDI Tri-display
- Type3 Interface Signals with MXM3.0 Gold Finger

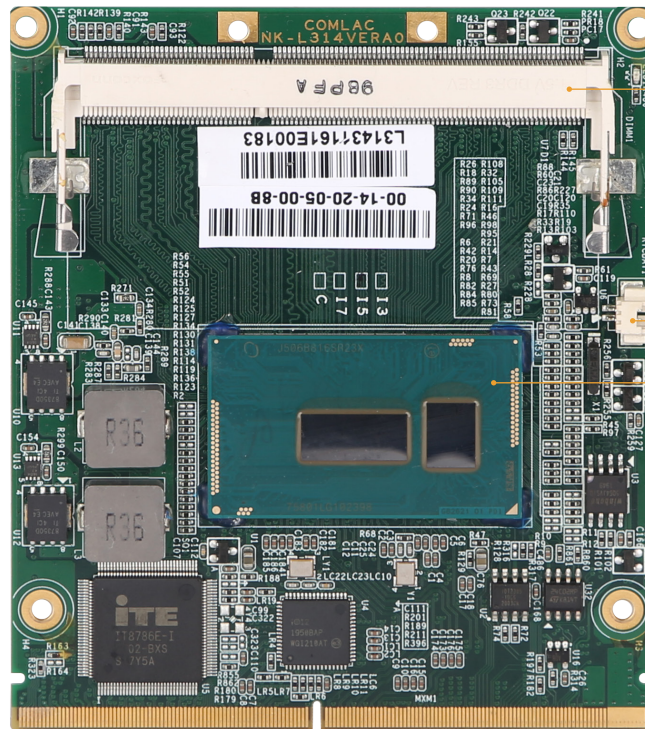

DDR3L SO-DIMM

BAT

5th Gen.U

规格 Specification

处理器 Processor System	CPU	Intel® 5th Gen. U Core Processors, TDP 15W
	芯片组 Chipset	Intel® SoC integrated
	BIOS	AMI 128Mb UEFI BIOS
内存 Memory	技术 Technology	Single Channel(Non-ECC) DDR3L-1333/1600MHz, up to 8GB
	插槽 Slot	1 x DDR3L 240-pin SO-DIMM slot
图形 Graphic	控制器 Controller	Intel HD graphics integrated
扩展信号 Expansion Signals	显示 Display	2 x DDI, 1 x eDP
	串口 Serial Port	2 x Uart(9line), 4 x Uart(3line)
	USB	2 x USB3.0, 8 x USB2.0
	SATA	2 x SATA 3.0
	PCIe	5 port 8 lanes(1 X4、4 X1)
	GPIO	1 x 4bit GPIO
	Audio	1 x Intel HDA Audio codec
	Fan	1 x Smart Fan
	网络 Ethernet	Intel i210AT controller
	其他 others	1 x I ² C, 1 x SMBus, 1 x LPC, 1 x Buzzer, 1 x KB/MS
看门狗定时器 Watchdog Timer	输出 & 间隔 Output&Interval	System reset, programmable from 1~255 seconds
电源 Power	Power input	5VDC
操作系统 OS Support	MS Windows	Windows 7/10
	Linux	Linux
机械参数 Mechanism	尺寸 Dimensions	(L)95mm x (W)82mm
	净重 Gross Weight	0.8kg
环境 Environment	温度 Temperature	Operating: 0°C ~60°C with SSD
		Storage: -40°C ~85°C
	湿度 Humidity	5~95% (Non-condensing)
	振动 Vibration	5~500Hz, 3Grms operating

框架图 Block Diagram

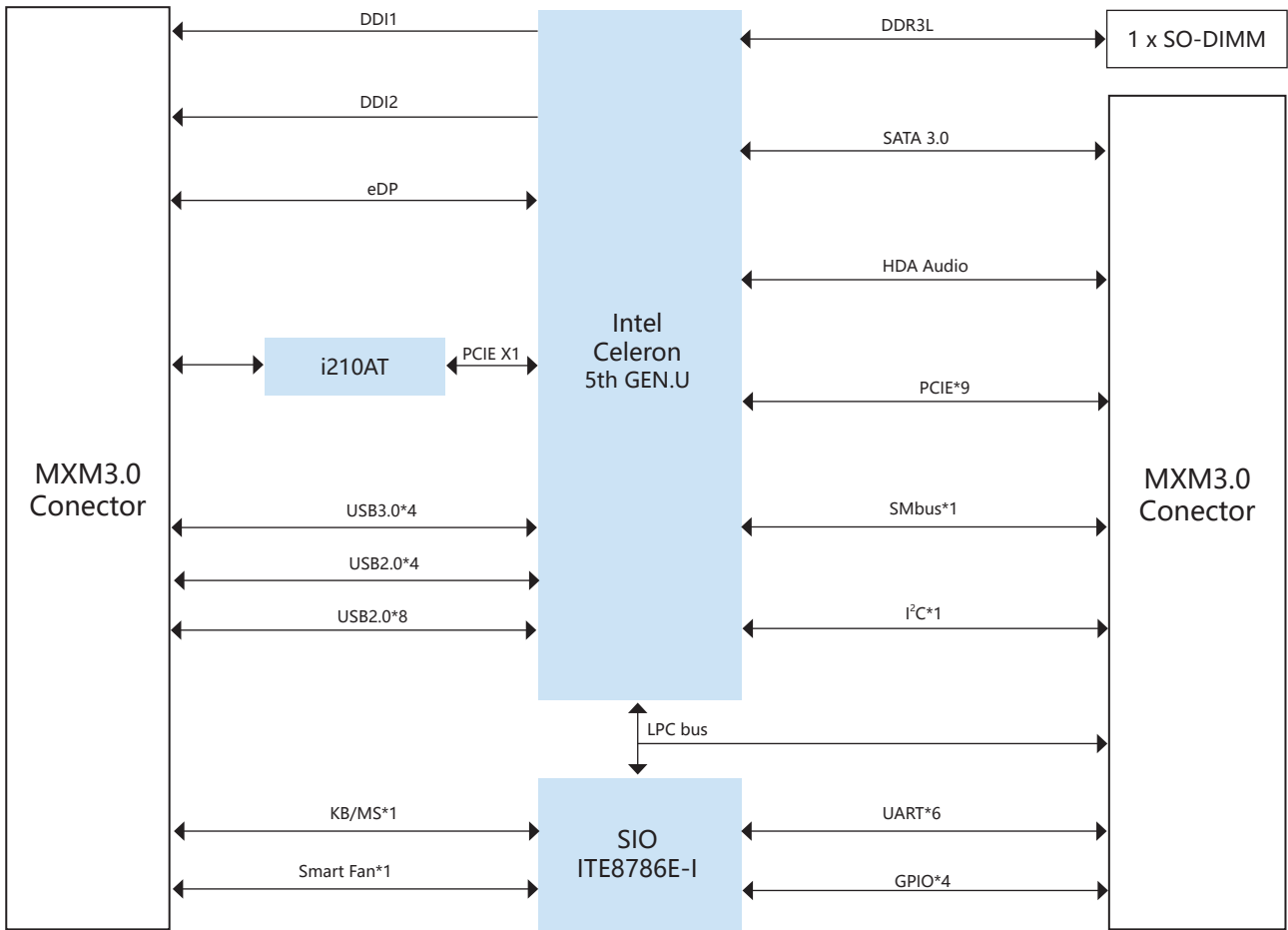

机构图 Mechanical Drawing

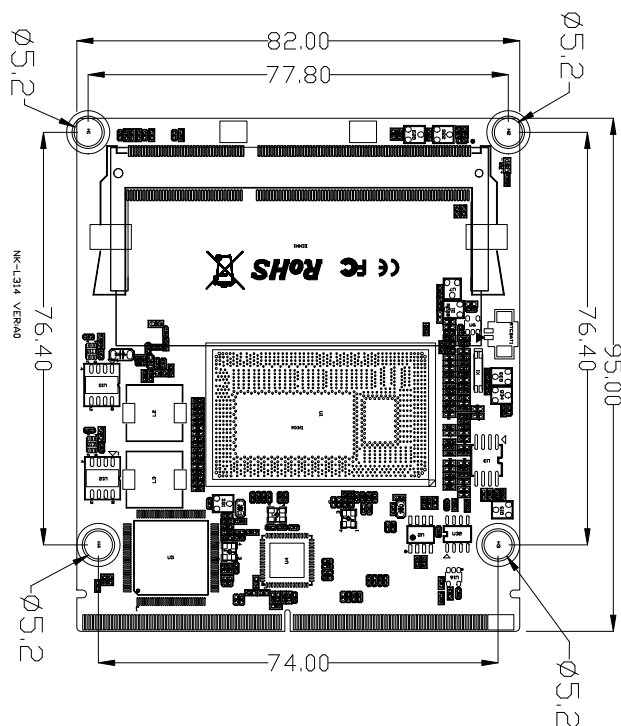

订购信息 Order Information

料号 Part No.	型号 Model	描述 Description
F04.L31403.A1.S35	NK-L314-5005U	Type 3,95*82mm Broadwell,5005U,1x DDR3L SO-DIMM
F04.L31401.A1.S35	NK-L314-5005U	Type 3,95*82mm Broadwell,5005U,1x DDR3L SO-DIMM
F04.L31402.A1.S35	NK-L314-5005U	Type 3,95*82mm Broadwell,5005U,1x DDR3L SO-DIMM

包装清单 Packing List

料号 Part No.	数量 Qty	描述 Description
	1	NK-L314 Comlac User manual